

Tracer® Electronic Flowmeter

Operating Instructions

General

The Tracer electronic Flowmeter provides the following information at the touch of a button:

- ◆ Flow Rate in gallons per minute (gpm) or liters per minute (lpm)
- ◆ Temperature (in degrees Fahrenheit or Celsius)
- ◆ BTU's per minute



BTU Basics

To obtain the most accurate BTU calculation, use the Tracer to measure the supply side water temperature (in °F) before installing the Tracer in a cooling water return line.

BTU's per minute calculation is based on the increase in water temperature times the flow rate. The Tracer Electronic Flowmeter calculates this information based on supply side temperature entered manually. Due to inherent differences in most thermometers, the most accurate BTU calculation will result from using the same thermometer (inside the Tracer) to measure supply and return line temperatures. Record the supply side temperature and enter it using the "Set BTU/m Input Temperature" instructions on page 3.

Application

Liquid running through the Tracer flowmeter should be free of metal shavings. Metal shavings will attach to the sensing magnet in the impeller, causing the unit to require extra maintenance.

Specifications

Flow

Size [NPT(F)]	Range (gpm)	Range (lpm)
3/8"	0.5 to 8	2 to 30
3/4"	2.0 to 20	8 to 76
1"	3.0 to 30	11 to 114
1-1/2"	6.5 to 60	25 to 228
2"	10.0 to 110	38 to 418

Accuracy.....±5% of Full Range
Repeatability.....±5% of Full Range

Temperature

Range.....32 to 230°F (0 to 110°C)
Accuracy.....±2% of Display Value
Repeatability.....±1% of Display Value

Environment

Tracer construction is weathertight, but is not submersible.

Component Materials

Body (3/8" model).....Nickel-Plated Brass
Body (3/4" thru 2").....Anodized Aluminum
Back Cover (3/8" only).....Polysulfone
Impeller.....Nylon 6/12
Magnet.....Neodymium
Shaft.....303 Stainless Steel
Electronics Cover.....Nylon 6/6

burger & brown engineering, inc.

4500 E 142nd Street • Grandview, MO 64030 • Tel. (816) 878-6675 • Fax (816) 878-8863 • www.smartflow-usa.com

Operating Instructions

There are two modes of operation for the Tracer Electronic Flowmeter: User Mode and Calibration Mode. User Mode displays all available process information. Calibration Mode configures the flowmeter for unit selection (°F, °C, lpm, and gpm) and automatic shut off. Calibration Mode also allows you to enter the information required to calculate BTU's.



Figure 1

User Mode

After pressing ON, press or buttons repeatedly to scroll continuously through displays of flow rate, temperature and BTU/m. After a few seconds (selectable in the calibration mode), the display shuts down automatically to conserve battery power.

View Flow Rate



Press ON. Flow rate and units (gpm or lpm) will be displayed. See Figure 1.

View Temperature



Press . Temperature and units (°F or °C) will be displayed. See Figure 2.

View BTU/m



Press . BTU's and units will be displayed. See Figure 3. To activate, enter calibration mode, and follow instructions to set input temperature found on page 3.



Figure 2

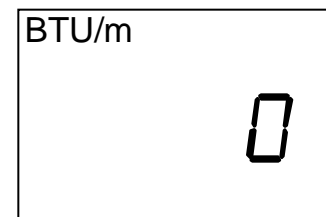
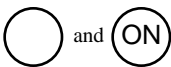

Figure 3

Calibration Mode

Calibration Mode allows the user to select English or Metric units, input BTU/m inlet temperature, and set auto shut-off time. and keys scroll through all options inside each display selection.

Enter Calibration Mode



The display must be off to enter Calibration Mode. Press and hold , then press ON. Flow rate units plus "Unit" and "SETUP" will be displayed. See Figure 4.

Select Flow Rate Units

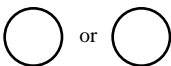

Press or to change units to gpm or lpm. Press ON when the desired unit is displayed. See Figure 4. Calibration mode will continue unless you exit. See page 3.

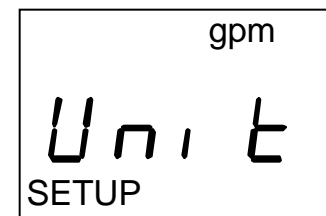
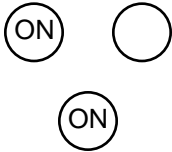

Figure 4

Calibration Mode (continued)

Exit Calibration Mode



Press ON repeatedly until the display reads “end”, then press . See figure 5. The display will read “off”, then press ON and the display will go blank.

or

Wait until the display shuts off automatically.

Select Temperature Units

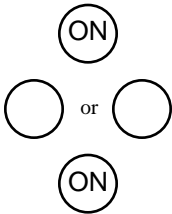

Enter Calibration Mode (see page 2). Press ON repeatedly until the display shows “°F” or “°C” in the upper right corner and “unit” in the center. See Figure 6. Press or to change units. Press ON when desired unit is displayed.

Calibration Mode will continue unless you exit.

Set BTU/m Input Temperature

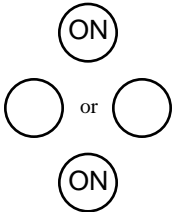

BTU calculation is available in English units only. See BTU Basics on page 1.

Enter Calibration Mode (see page 2). Press ON repeatedly until the display shows “BTU/m” in the upper left corner. See Figure 7. Press or to change input temperature (40 to 220°F). Press ON when desired unit is displayed.

Note: If you try to set the temperature input to less than 40°F, the display will show “off” and BTU/m display will deactivate.

Calibration Mode will continue unless you exit.

Set Automatic Display Shut-off Time

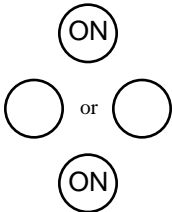

Enter Calibration Mode (see page 2). Press ON repeatedly until the display reads “Auto” in the center. See Figure 8. Press or to change shut-off time (15 to 240 seconds). Press ON when desired shut-off time is displayed.

Note: if you press until the time shut-off goes past 240 seconds, the display will show “off”, and the automatic shut-off feature will deactivate. The display will be off or on until you press ON to change it.

Reactivate BTU/m or Automatic Display Shut-off Time

Follow the instructions to set (above) and press or to display a value instead of “off”, and press ON to set.

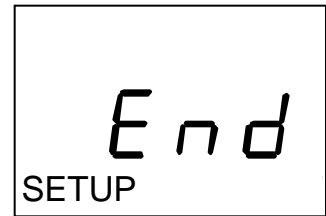

Figure 5

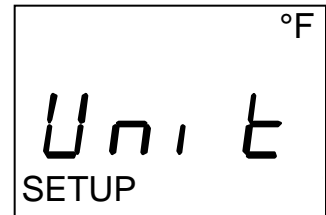

Figure 6

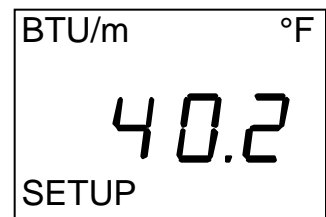

Figure 7

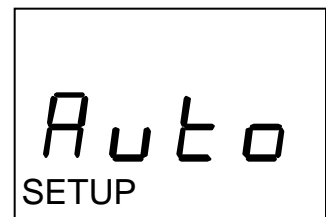
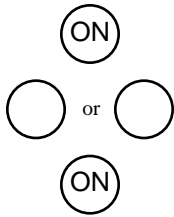

Figure 8

Set Flow Rate Display Filter



The Tracer flowmeter responds to flow changes very rapidly. Turbulent flow occurs when water is flowing above 3.3 GPM or 12.5 LPM. The impeller changes speed as the water is swirling and mixing while passing through the meter. The filter program stabilizes the display reading for the meter by averaging readings from the impeller. A larger filter number results in a smoother flow rate display. The filter program causes a delay in the flow reading upon start-up while performing the initial averaging function.

Enter the calibration mode (see page 2). Press ON repeatedly until the display reads "Filt" (see figure 9) Press or to change the amount of filtering (1 to 32). Press ON when desired filter is displayed. Press less than 1 to turn off the filter.

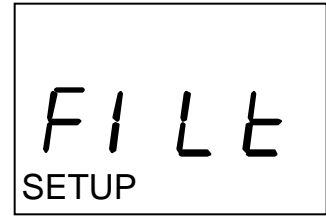
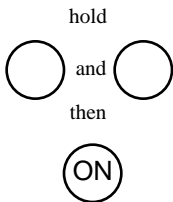

Figure 9

Advanced Calibration Mode

Advanced calibration mode allows the user to adjust the calibration values for flow and temperature. Other functions include LCD self-test, Battery voltage display and low battery warning set point adjustment. There are eight functions or displays available through this mode. The ON button scrolls the menu through all eight functions until the user turns the display off. **The flowmeter will not turn off automatically in this mode. It is very important that the user turn off the display after using these functions!**

Start Advanced Calibration Mode



The unit must be off to enter this mode. Press and hold both directional arrow buttons, then press ON. CAL will be displayed. See Figure 10. To scroll through the advanced calibration mode, press the ON button. If the ON button is not pushed within three seconds, the unit will automatically shut off.

Software Version



By pressing ON once after entering the advanced calibration mode, the software version will display. See Figure 11. There is no adjustment to be made.

EEPR



This function resets the calibration values to the program defaults. See Figure 12. **It is not recommended to reset these values!** This will take the Tracer flowmeter back to pre-calibrated settings. The flowmeter must be re-calibrated if this is done.



Figure 10

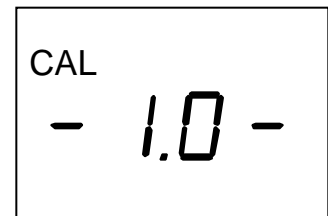

Figure 11



Figure 12



Flow Calibration Value

Increase or decrease this number by using the arrow keys. See Figure 13. **Increasing** the calibration value by 20 units **lowers** the flow display by .1 gpm. See the Flow Calibration Procedure below.

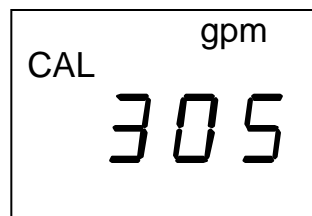

Figure 13



Temperature Calibration Value

Increase or decrease this number by using the arrow keys. See Figure 14. **Increasing** the calibration value by 10 units **raises** the temperature display by 1 degree F.

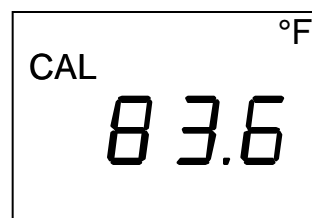
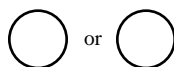

Figure 14



Temperature Slope Calibration Value

Do not adjust.



Low Battery Display and Battery Voltage

Sets the low voltage required to display the "LOW BATT" message. After three seconds the display automatically shows the actual battery voltage. See Figure 15. Factory setting is 2.60.

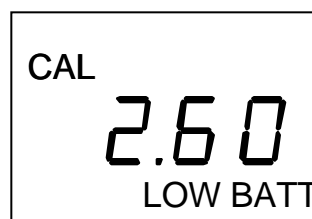
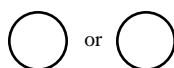

Figure 15



LCD Test Screen

See Figure 16. By pushing either arrow button, "test" will display. By pushing the ON button while "test" is displayed, the LCD will run a self-test.

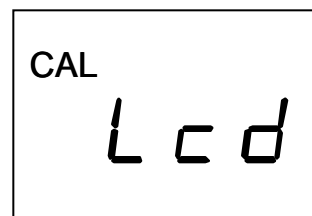
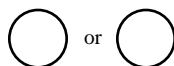

Figure 16



End Screen

By pressing either arrow button the display will change to "OFF". Press the ON button to turn off the display.



Flow Calibration Procedure

- Tools Required:
- Five Gallon (minimum) Calibrated Container
 - Stopwatch
 - Valved Water Supply

See Figure 17 for an example of the test configuration.

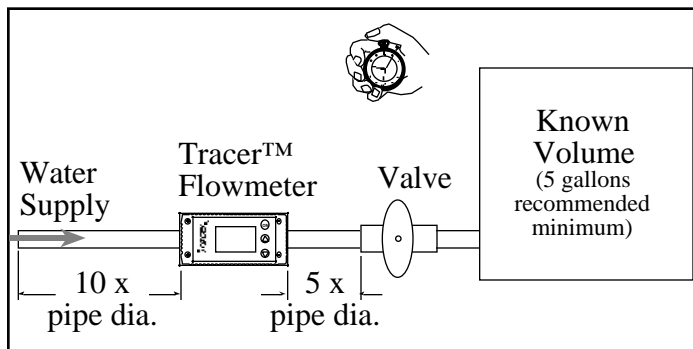

Figure 17

Before you begin: Purge all the air from the system by running liquid through the test apparatus.

For best results, take readings as close to full range as possible (5 gpm for the 3/8"NPT and 2.5gpm for the 1/4"NPT unit).

1. Push the ON button on the Tracer flowmeter.
2. Turn valve to full open position quickly and start timer simultaneously.
3. Record gpm display on the Tracer flowmeter.
4. When the liquid reaches the selected level in the container, stop timing and close the valve.
5. Divide the volume in gallons from the container by time **in minutes** from the stopwatch to determine gpm.
6. Plug the numbers into the following formula:
Tracer reading - manual reading = difference
Multiply the difference x 200.
7. Add the resulting number (positive or negative) to the Flow Calibration Value in the Advanced Calibration Mode. Use the Advanced Calibration Mode to change the flow calibration value, as shown on page 5.

Temperature Calibration Procedure

Tools Required:

Accurate Temperature Measuring Device

Water Supply

See Figure 18 for an example of the test configuration.

For best results, temperature calibration should be performed with liquid flowing through the Tracer flowmeter

1. Stabilize the temperature by allowing water to run through the circuit to run for a few minutes.
2. Press ON on the Tracer Flowmeter, then to display the temperature in degrees Fahrenheit.
3. Record the temperature shown.
6. Plug the numbers into the following formula:
Measuring device reading - Tracer Flowmeter reading = difference
Multiply the difference x 10.
7. Add the resulting number (positive or negative) to the Temperature Calibration Value in the Advanced Calibration Mode. Use the Advanced Calibration Mode to change the temperature calibration value, as shown on page 5.

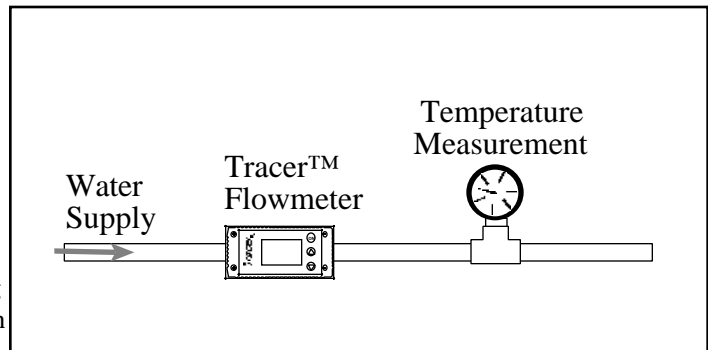

Figure 18

Maintenance Instructions

Calibration

Annual calibration is recommended. Return to the factory for calibration, or follow the Flow and Temperature Calibration Procedures on pages 5 and 6.

Low Battery

Check the display on the Tracer periodically for a low battery message (See Figure 19). When this appears, follow the instructions below.

1. Carefully remove the four screws holding down the black molded cover of the Tracer Electronic Flowmeter.
2. Replace the battery:

Replacement Battery Requirements

Model TADIRAN 5902
Nominal Voltage.....3.6V
Nominal Discharge Current.....1.0mA
Cell Size.....1/2AA

3. Replace the cover and four screws.

Caution: Do not blow compressed air through the flowmeter. Damage to the turbine may result.

Drain liquid from inside Tracer flowmeter when not in use to prevent build-up of scale and mineral deposits.

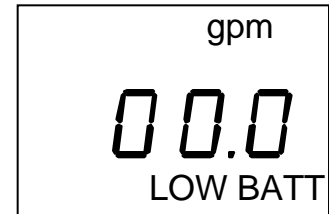

Figure 19

Chemical Compatibility

The following is a list of chemicals that are not compatible with the UDEL Polysulfone used in the Tracer Electronic Flowmeter. Contact Burger & Brown Engineering for more detailed information.

Please contact us for further information.

Burger & Brown Engineering, Inc.

1700 E 123rd Street

Olathe, Kansas 66061

Tel: 1-800-764-3518

Fax: 913-764-1714

www.smartflow-usa.com

Acetone, Methyl Ethyl Ketone	Methylene Chloride
Benzene	Tetrachloroethylene
Carbon Tetrachloride	1,1,2,2-Tetrachloroethane
Chlorobenzene	Toluene
Chloroform	1,1,1-Trichloroethane
Cyclohexanone	Trichloroethylene
Esters	Xylene
Freon TA	

Limited Warranty

Seller warrants that this product supplied will conform to the description herein stated and that the product will be of standard quality. This is the sole warranty made by Seller with respect to this product. Seller expressly disclaims any other express or implied warranties, including, but not limited to, the implied warranty of merchantability and the implied warranty of fitness for a particular purpose.

Seller shall not be liable for any cost or damages, whether direct, incidental or consequential, including, but not limited to, any injury, loss or damage resulting from the use of this product, regardless of whether any claim for such cost or damages is based on warranty, contract, negligence, tort or strict liability. The sole liability of Seller is limited to repairing or replacing this product.

this warranty shall not apply to any products that have been repaired or altered by anyone other than Seller. The warranty shall not apply to any products subject to misuse due to common negligence or accident, nor to any products manufactured by Seller which are not installed or operated in accordance with the printed instructions of Seller or which have been operated beyond the rated capacity of the goods. Seller states that the product's useful safe life is 5 years. Actual life may vary widely depending on operating environment such as temperature, pressure, and chemical exposure. Users are cautioned to refer to instructions for operating limits and a partial list of incompatible chemicals.

burger & brown engineering
816-878-6675